

Hobie

GETAWAY

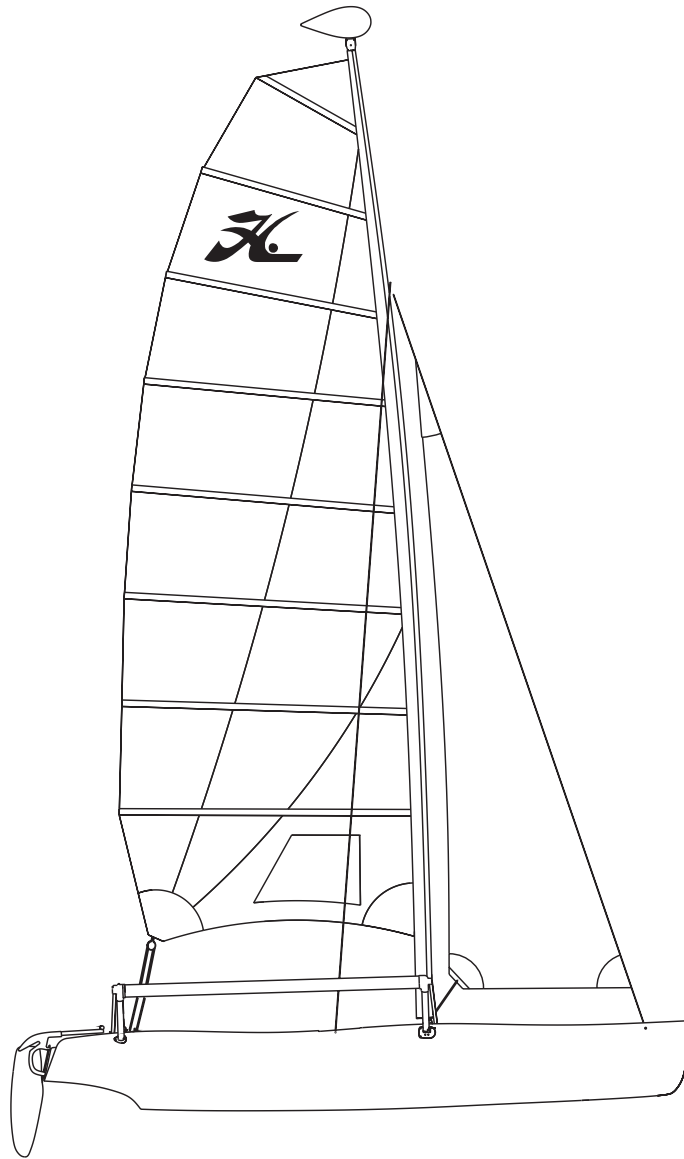

ASSEMBLY MANUAL



WELCOME TO THE HOBIE WAY OF LIFE

Congratulations on the purchase of your new HOBIE Getaway and welcome to the HOBIE® sailing family. The HOBIE Getaway cannot be outgrown. It can be sailed by children up through senior citizens. A single adult can sail it at top performance - and a crew of four can cruise in comfort.

We offer this manual as a guide to increased safety and enjoyment of your new boat. The purpose of this publication is to provide easy, simple and accurate instructions on how to get your Getaway ready for the water. Please read them carefully and familiarize yourself with the boat and all of the parts spread before you.

Whether you are a new sailor or a veteran of many years, we recommend that you read this thoroughly before your first sail and TRY IT OUR WAY FIRST! If you are new to sailing, this manual alone is not intended to teach you how to sail. There are many excellent books, videos and courses on the safe handling of small sailboats. We suggest that you contact your local sailboat dealer, college or Coast Guard Auxiliary for recommendations.

Watch for overhead wires whenever you are rigging, launching, sailing or trailering with the mast up. CONTACT OF THE MAST WITH POWER LINES COULD BE FATAL! Be certain that the rigging area and the area that you will be sailing in are free of overhead power lines. Report any such power lines to your local power authority and sail elsewhere.

We take pride in presenting the Getaway to you and hope that you'll take as much pride in owning her.

Fair winds and good sailing!

Hobie.

GETAWAY ASSEMBLY MANUAL

This assembly manual takes you step-by-step through the setting-up and sailing of your new HOBIE *Getaway*.

This manual will help you understand each part in detail.



Setting up your <i>Getaway</i>	PAGE
Getaway terminology.....	2
List of parts.....	3
Knots to use	4
The hulls.....	4
Crossbars & Trampolines.....	4-7
Mast assembly	8-9
Mast Wires	9
Stepping the mast.....	9-10
Main Sail and Battens	10-11
Raising the main sail	11
Downhaul and adjustment.....	11
Mainsheet.....	12
Rigging the jib sail	12
Rudder assembly	13
Tiller cross bar and Extension	13
Righting line.....	13

Sailing your <i>Getaway</i>	PAGE
Balancing the boat	14
Steering	14
Sail power.....	14
Turning.....	15
Launching.....	15
Righting the boat.....	15
Docking and landing	16
Rudder tuning.....	16
Trailing	17
Safety tips	Back page



Getaway Terminology

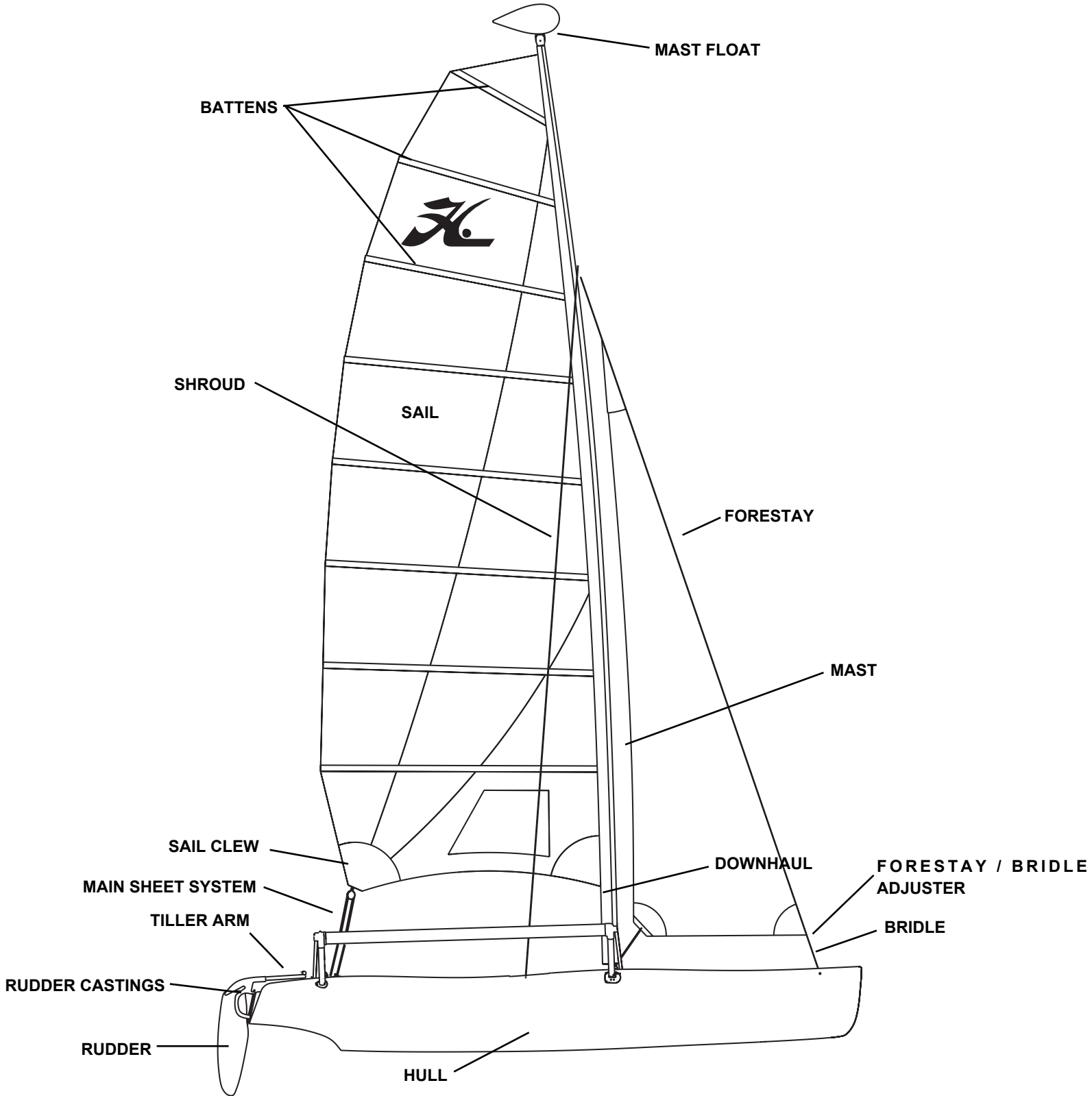

LIST OF PARTS

Check the boat and parts carefully to be sure that all of the parts are present and that the boat is in good order.

SMALL PARTS

- Mainsheet system
- Downhaul line
- Righting line
- Shroud wires
- Main halyard line
- Trampoline lace lines

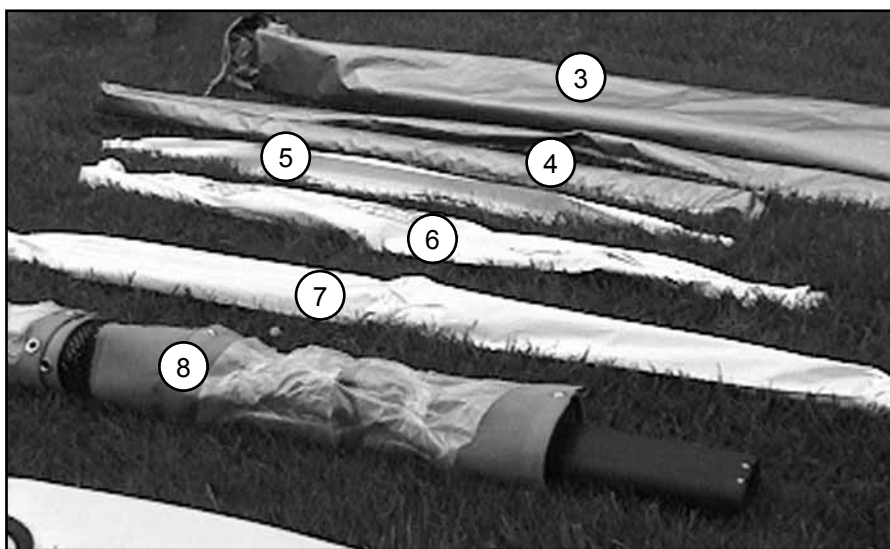
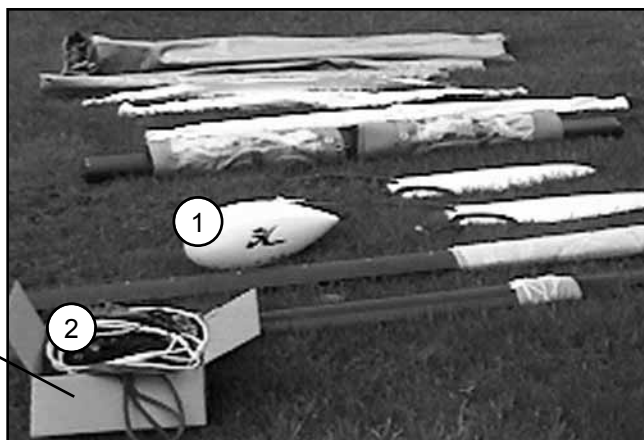

LARGE PARTS

You should have:

- (2) Hulls with hardware
- ① (1) Mast float
- ② (1) Box of small parts
- ③ (1) Sail, battens and sail bag
- ④ (1) Forestay assembly with jib, bag
- ⑤ (1) Tiller cross bar, Tramp rods
- ⑥ (1) Front cross bar (Spreader)
- ⑦ (1) Rear cross bar
- ⑧ (1) Main cross bar (Mid) with Trampoline
- ⑨ (2) Rudder assemblies

NOT SHOWN:

- (1) Upper mast section
- (1) Lower mast section
- (2) Trampoline lace rods



KNOTS TO USE



FIGURE 8 KNOT



BOWLINE KNOT

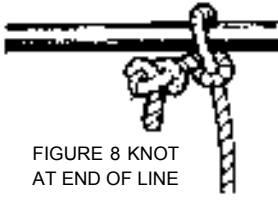
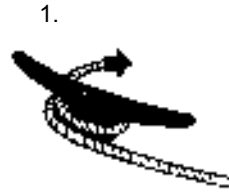

FIGURE 8 KNOT
AT END OF LINE

HALYARD KNOT



1.



2.

CLEATING OFF A LINE

ASSEMBLY INSTRUCTIONS



THE HULLS

Lay the hulls on the ground, on their sides with bottoms to the center (graphics down), as shown above. A tarpoline or pads under the hull may be desirable if the ground surface is rough. Place the hulls about seven feet apart.

Note: There is one plug in the rear of each hull. These plugs are used to drain the hulls. The plugs should be in place before sailing. Remove the plugs after sailing to drain any water that may have leaked into the hulls. It is best to travel with and store the boat with the plugs removed to allow for pressure changes due to heating, cooling and altitude changes. This will prevent warping of the hull surface.

The rear crossbar has the main sheet traveler car and swivel cam cleat installed. Position it near the aft crossbar sleeve in each hull.

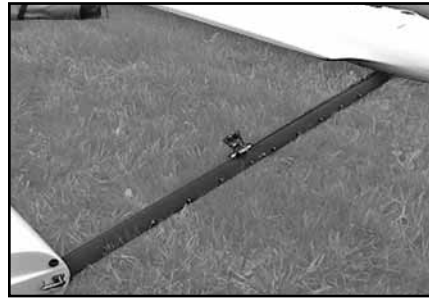

Main Beam with Trampoline

CROSSBARS AND TRAMPOLINES

The forward and main trampolines are rolled onto the front crossbar. Position the crossbar between the hulls near the forward cross bar sleeve in each hull.



The Bow Spreader Bar has slides, eye straps, bridle wires (2) and the roller furler installed. Position it near the recesses on each bow.

Remove the bolt that is threaded into the plastic block on each end of the Bow Spreader Pole.

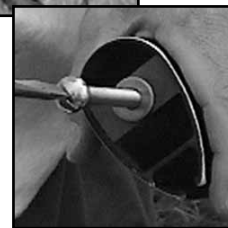

Insert the crossbars into one hull. See that the crossbars seat fully into their sockets in the hull.

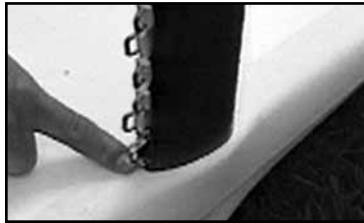
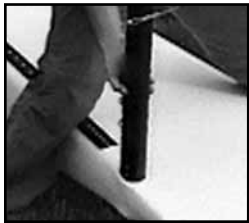

Using a cross bar as a lever arm, pull the hull to an upright position so that the crossbars are horizontal.



Slide the other hull onto the crossbars until the hulls come in contact with the stop plates (located on the underside of the main and aft crossbars).



Lifting one hull, or the other, at the rear can help align the socket for the forward spreader bar.



Be sure the forward spreader is fully seated in both hulls.



Re-Install the screws into each end form the outside of the hull. Do not over tighten or compress the plastic hull material.

Unroll the trampolines from the forward crossbar. Slide the main trampoline bolt ropes into the hull trampoline tracks. Soapy water can be used as a lubricant (Do not use an oil or silicon lubricant on the trampoline track or the bolt rope). Sliding the bolt rope into the track is a 2 person job. One person should pull the trampoline and the other feed the bolt rope into the track.

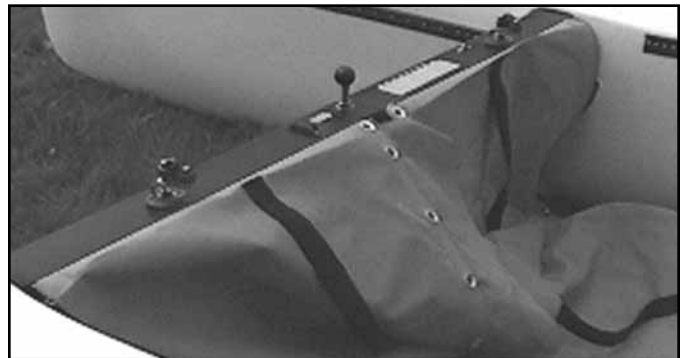

After both main trampoline halves are in place, but not laced, install the forward trampoline following the same technique as with the main. Except, because the forward trampoline is one piece, it is necessary to alternate from side to side while feeding it into the tracks.



Carefully feed the trampoline into the tracks.



Continue to feed the trampoline equally on both sides.



As the trampoline becomes more difficult to feed, Alternate from one side to the other keeping the trampoline somewhat even. You can sit or lay on the trampoline to stretch it a bit.



Work your way across the trampoline to the other side, then tie off with half hitches.



Once the forward trampoline is nearly all the way into the track it may be necessary to use the Bow Spreader Pole for leverage to pull it taught. Tie a lace line to the grommet. Wrap the line around the beam and then pass it back through the grommet again. This will create a 3:1 purchase to help pull the trampoline forward. Once again, alternate from side to side to keep the trampoline even. Carefully feed at the opposite end to prevent the trampoline from getting wedged in the track opening. Pull the trampoline all the way tight.

LACE FORWARD TRAMPOLINE - Slide the longer (of the two provided) lace rod into the forward trampolines pocket. Tie the lace line to the eyelet.



Pass the line through the grommet in the trampoline.



Pass the line back through the eyelet, then over to the first slide. Pass the line to the first cutout and around the rod. Then back to the first slide.



Continue to each slide and cutout across the tramp. Come back to the starting point and begin tightening the lace line to pull the trampoline tight.

Work your way across the trampoline to the other side, then tie off with half hitches.



LACE MAIN TRAMPOLINE - Tie a bowline knot to the forward left/port grommet in the trampoline.



Pass the line through the opposite grommet, top/down and then through the lacing flap.



Come up through the next (left) grommet and then continue to lace towards the aft of the trampoline following this pattern (down through the right grommets and up through the left grommets). Keep

the laces loose at this time. Lace as far aft as the line will go.



Locate the aft lace rod. Feed the rod through the rear pocket as shown. Center the rod, from left to right, in the pocket.



Locate the aft lace lines. Tie to the rear grommets using a long looped bowline as shown (left and right sides).



Let the tramp hang below the aft crossbar. Pull the lace lines under the crossbar and tight. Begin the aft lacing by routing the left line up and over the first lace peg.



Cross over to the next peg then down and around the rod. Pull the lace line tight then up and over the peg and then over to the next one and so on... Then start with the right side and work towards the

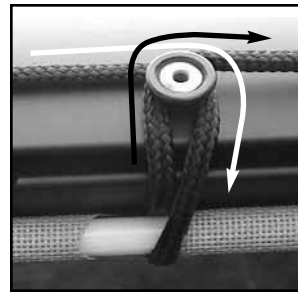

center. Image to left shows the proper routing of the lace lines around rod and peg.



When you reach the center, the pattern must be changed slightly. Pass up and over the last peg, before the center, and then down around the rod in the gap between tramp halves.

Then, come up and through the trampoline grommet on the opposite side. Once tied off loosely at the center, cinch the line tight from each side working towards the center.



Tie off to the main trampoline grommets just forward of the aft crossbar.



Once the aft lace is tight, begin cinching the center lace tight from forward to aft. You will notice that as you get the trampoline tight you will have more lace line aft to complete the lacing.



Work your way aft until the entire trampoline is tight. Tie off the line with a few half hitches.



Tuck the lace flap into the opposite side lace line. The flap will help keep you drier while sailing and keep lines from slipping into the water between the laces.



MAST ASSEMBLY

WARNING!! *The lower section of the mast is aluminum and displays warnings against assembling and sailing near overhead wires and power lines. The upper section is fiberglass and is designed to help prevent injury that can occur if the mast does contact a high power line. Before raising the mast, check that you are in a safe area and always remember this warning.*



*** Getaway mast extrusion to CompTip assembly** (normally performed by dealer prior to delivery)

The purpose is to bond the two section together and seal out water. This will also keep the joint in proper alignment. This can affect sail shape if the fit becomes loose.

Use some masking tape or the like, and mask off the area above and below the joint to make clean up easier. Also block off the luff tracks to prevent glue from bridging the sail openings due to excess glue oozing out of the joint.

Be prepared to use force during the insertion. Air trapped inside the joint can prevent easy insertion. *(The small black cap just below the joint can be removed and an air-release path can be poked through the foam if needed.)* Place the mast on saw horses or blocks. Place the base of the mast against a solid, padded object.

Apply the bonding agent to the inside and outside of the mating sections. Fit the two parts together as far as possible. If force is required, hold the upper section and pull the entire assembly a few inches away from the "solid object" (wall, tree, post) slide the assembly up against the "solid object" with some force. When the mast assembly (base) contacts the "solid object" the inertia will help slide the CompTip (upper section) deeper into the lower section. Repeat as many times as necessary to fully seat the sections together.

Prop the mast up so that the track is straight up and then sight down the length with your eye to check the alignment at the joint. Straighten if necessary.

Remove masking tape before glue dries.

Allow bonding agent to dry.

Insert the upper section into the lower section. *We recommend that the upper section be bonded into the lower section with epoxy. The mast can be used without bonding the upper section into the lower to make storage easier if desired.



Install the mast float to the upper mast section as shown. Be sure the blunt end of the float is facing forward towards blunt side of the mast. You may have to loosen the bracket bolts that pass through the mast head to get the screws aligned in the float.



Pass the halyard line through the mast head from rear (track side) to front. Pull both ends of the halyard down the mast and tie off at the halyard cleat on the side of the mast near the base.

MAST ASSEMBLY



To step the mast upright, position the mast base next to the mast step ball. The mast top and float should be positioned to the rear of the boat in the center of the rear crossbar. The arrow stickers on the mast and main crossbar must be aligned.



Turn the mast onto it's side to align the arrows.

MAST ASSEMBLY continued...

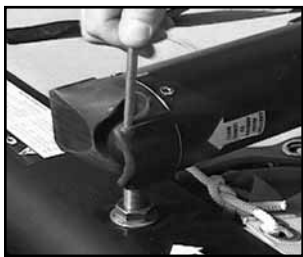

Connect the mast base to the step ball by positioning the step ball inside the mast base cup.

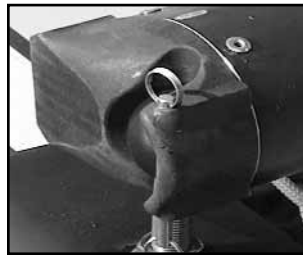

Pass the pin through the mast base as shown. Pass the ring through the pin to keep it captive. This pin should remain in place while sailing.

MAST WIRES



Locate the mast wires and uncoil. There are two side stays attached to a shackle. Find the jib assembly with swivel and upper pig tail. Pull all three wires to the mast tang. Hang the pigtail wire between the two side stay wires on the shackle.

Attach the shackle to the lower hole in the mast tang. Tighten the screw pin with pliers.



Use the safety wire provided to keep the pin from backing out due to vibration. Thread the wire through the pin head and around the shackle hoop. Twist the ends together with pliers to lock the pin in place.

Route the two side stays to each hull. Be sure there are no tangles or twists in the wires. The wire that crosses the mast should be routed over (on top of) the mast.



Check to be sure the wires are not crossed. Check that they are clear to allow the mast to swing to the upright position.

Once again, check the wires to see that they are positioned properly on the mast tang shackle and that they are routed to the hulls over the mast.



Attach the adjusters to each hull as shown. Be sure the adjuster cover boots are installed on the wires first. Attach the side stay (shroud) wires to the top hole on each side of the boat.

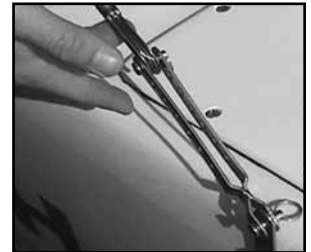

Slide the boots over the wire and adjusters.



WARNING!!

Watch for overhead power lines. Never rig, trailer or sail the boat near overhead power lines. Mast contact with a power line could be fatal.

STEPPING THE MAST



Before continuing, once again check for overhead power line wires that could contact the mast when raising it or when moving to the water for launching.

Stand on the trampoline near the rear crossbar and lift the mast to your shoulder.



STEPPING THE MAST continued...



Be sure to keep the arrows at the mast base and front crossbar aligned. Face forward on the boat with a wide stance for stability. Walk forward while lifting the mast until the side shrouds go tight preventing the mast from further forward movement.

Lean your weight against the mast to hold it in this position. The mast base/crossbar arrow alignment is no longer required.



Insert the forestay adjuster into the furler drum one or two holes and pin in place.

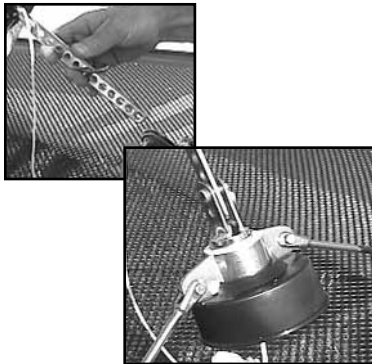
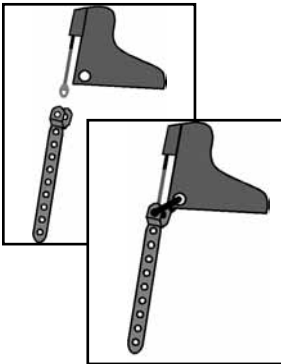

Run the furling line from the drum to the cleat next to the mast. Pass the line through the cleat and tie a small figure 8 knot in the end of the line to keep it from slipping back through the cleat.

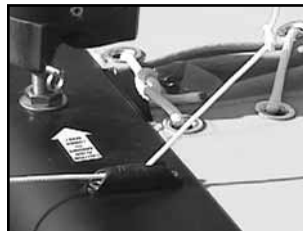

At this time, pull the furling line to unwind the drum completely. The drum will be rewind when the sail is unfurled.

After stepping the mast, adjustments can be made to tension the wires and for raking the mast forward or aft. Positioning the shrouds lower in the shroud adjusters will rake (lean) the mast aft. This can help boat-handling in higher winds.

There is a limit to the amount of mast rake aft that is possible. This will be seen when the main sail block on the sail clew nears or touches the block attached to the rear crossbar when fully sheeted while sailing. Too much mast rake will not allow you to sheet the sail properly. It may also be more difficult to tack the boat.



At this time adjust / tension the shroud wires lower in their adjuster plates, one side at a time. Use the main halyard to hold the mast up while your crew makes the adjustments. **Be very careful to tie off the halyard at the mast cleat in such a way as it will not slip during this process.**

You will be holding the mast with this line alone. Step aft and away from the boat on the side to be adjusted. Tension the halyard line to ease the shroud tension on that side. Lower one side a few holes then refasten the keeper pin and ring. Do the same for the opposite side. Repeat until all three mast supporting wires are taunt and the shroud wires are as nearly equally adjusted as possible. Once the proper adjustments are made, you will not have to repeat this process again. Unless you want to make adjustments to the mast rake angle.

MAIN SAIL AND BATTENS.



Unfurl the sail on the trampoline. Getaway sails are shipped from the factory with the battens installed. It is important that the means of securing the battens in the sail be understood.

Note that the batten ends have a "V" jam cleat molded into them.

These "V" jam cleats will keep the tension line from slipping in only one direction. Note the hollowed-out side of the cleats. Pull the line from the flush side toward the hollowed side when cleating.

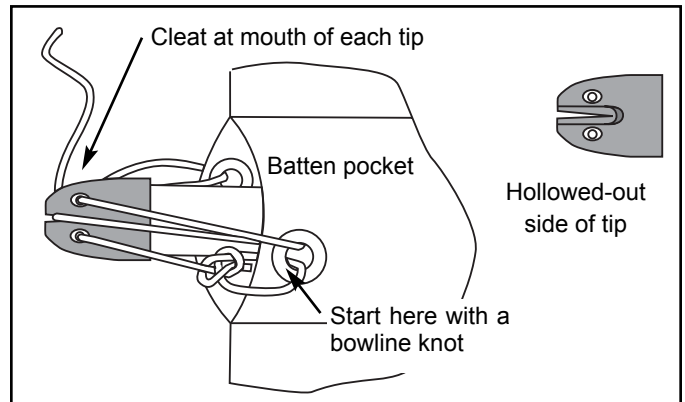



The lines are threaded through each batten end cap but are not tensioned. To tension the battens, pull tension on the line forcing the batten into the pocket and cleat it.



Tension each batten so that the batten is well seated and the wrinkles in the batten pockets are removed. Excessive batten tension will cause the sail to be more difficult to handle. Many sailors release the batten tension at the end of the day. This action releases the pressure that might otherwise be stretching the sail while it is not in use.



Tie a small figure 8 knot in the end of each line to prevent the battens from falling from the sail if the line releases from the cleat. For extra security, tuck the line under itself. This insures that the line will not work it's way loose from the jam cleat.

RAISING THE MAIN SAIL



As shown, hook the halyard to the top of the sail.



Feed the top portion of sail into the mast track opening.



Begin pulling on the halyard line. Use caution to be sure the sail feeds smoothly into the mast while raising.



It will be necessary to help feed the sail into the track while hoisting.



Hoist the sail all the way to the top of the mast.

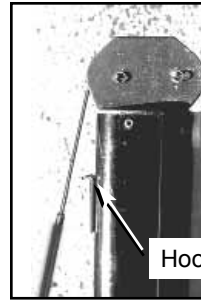

Once the sail is fully hoisted, pull the halyard, with tension, forward and away from the mast. Then pull the line back against the mast. (Keep the line centered with the mast). This will place the locking bead below the "2 fingered" hook. Release the halyard to engage the hook. Repeat the process if the sail does not remain at the top of the mast. Tie off the halyard to the cleat.



DOWNHAUL AND ADJUSTMENT



Tie the downhaul line to the grommet at the bottom of the main sail nearest the mast. Use a bowline knot.



Pass the line down and through the downhaul cleat located in the mast track.



Pass the line back up and through the downhaul (tack) grommet. Using the 3:1 purchase this creates, tension the luff of the sail until the sail looks smooth and horizontal wrinkles are removed.

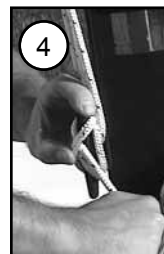

Tie off the line at the cleat.

The downhaul should be tensioned just enough to remove the horizontal wrinkles in the sail luff (forward area). The boat will perform best with light tension in light air and a bit more when the wind is stronger. When not sailing, totally relieving the tension on the downhaul will greatly reduce sail flogging from wind.



MAINSHEET SYSTEM



Connect the main sheet block to the traveler car. Attach the shackle that is part of the block through the clevis pin on the traveler car. Hook the mainsheet to the "clew" grommet at the rear of the main sail.



The tail end of the main sheet line is used for traveler adjustment. Pass this line end through the swivel cleat jaws (from forward towards rear of the boat) then eye. Pass the line through the traveler car. Pass the line through

the stainless eye on the rear side of the cross bar. Tie a figure 8 knot in the end of the line to keep it from coming out of the eye. When sailing upwind, cleat the traveler more to the center of the boat. On a reach across the wind or when sailing downwind adjust and cleat the traveler further out the track. When sailing in strong winds you can move the car further out to help keep the boat more level and limit heeling or tipping.



Keep the mainsheets loose when the boat is on the beach to prevent an accidental capsize.

RIGGING THE JIB SAIL



Thread the jib sheet line starting from the eye next to the starboard (right side) swivel cleat. Pass the line through the stainless eye and tie a figure 8 knot. Thread the onthe end through one of the jib clew blocks and then through the swivel cleat. Pass the line through the swivel eye and then the jaw and onto the main

trampoline. Cross over to the port (left) side and repeat the process in reverse ending at the stainless eye with another figure 8 knot.



The jib is furled on the forestay and covered by a "snorkel". To remove the snorkel, simply unzip as it is pulled down.



The jib is held furled by a snap hook that is attached to the jib clew. Before releasing the snap hook, spin the jib clockwise 2 or 3 turns to start spooling the furler line onto the furler spool. Release the hook from the loop and attach the 2 jib clew blocks to the snap hook. The jib can now

be unfurled by pulling on the jib clew or tightening one side of the jib sheets. This action will automatically roll the furling line onto the furler spool as the jib un-furls. ***(If the jib is not furled and the line is also not loaded in the drum, wrap the jib around the forestay until it is furled. Then when you unfurl, it will load the drum as desired.)***



To furl the jib, ease off on the mainsheet tension and release the jib sheets, pull on the jib furler line. Keep light tension on the jib sheet as the sail is being furled to get a nice tight wrap. Cleat the furler line in the furler cleat to keep the sail furled.

There is a luff adjustment line that is installed at the jib top (head) and may need to be adjusted. While the mainsheet is tensioned, and the forestay is taunt, there should be just enough tension to smooth the sail and remove the horizontal wrinkles at the luff. Too much tension can damage the sail or pull the head or tack grommet out when under sailing loads. To adjust the line you must tip the boat onto it's side or drop the mast down to access the tensioning line at the jib top.

If the boat is being put away for the day the snorkel should be installed. To do so, unhook the jib clew blocks and snap the hook onto the loop sewn into the sail. This will keep the sail tightly furled while the snorkel is installed. Re-attach the zipper and slide the snorkel up the sail as it is zipped up.



The main halyard can be used to pull the snorkel up over the jib, but if the sail is tightly furled, the halyard will not be required. Route the halyard under a shroud and hook to the snorkel and hoist. Tie the halyard to the halyard cleat.



RUDDER ASSEMBLY

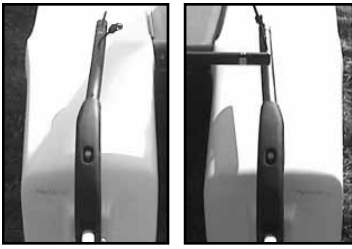

There is a left and a right rudder. Note the arms extending from the upper rudder castings. These "upper rudder" castings have an angle molded into them. The arms should be angled towards the center of the boat. You will also see a colored tab on the end of each arm, one green, one red. The red tab indicates the left rudder and the green the right.



As shown, line up the rudder pintles (metal pegs on the hulls) with the rudder castings (holes with plastic bushings). Push the rudder castings down onto the pintles. The rudder arm may need to be unlocked to allow easy positioning.



Insert the retainer pins to lock the rudders in place. The pins will prevent the rudders from falling off the boat in the event of a capsize.

The rudders are locked in the down position by pushing the rudder arm aft which will seat the rudder. Push the arm down to engage the locking cam. To release, lift the arm, then pull the arm forward until the rudder is in the "up" position. Place the arm down to engage the upper casting with the lower casting. Beaching will automatically release the rudders. Keep a small amount of lubricating grease on the plunger and cam mechanism. If this assembly becomes dry, it will inhibit proper function.

TILLER CROSSBAR AND EXTENSION



The rudder arms are connected by a bar called the tiller crossbar. One end is labeled starboard (right) and the other port (left). There is a hole in each end of the tiller crossbar and a pin on swivel on each rudder (tiller) arm. The pin is to be inserted into the hole in the arm such that

the tiller crossbar is above the tiller arm and the tiller extension is on top of the tiller crossbar. Capture the tiller arm to the tiller crossbar with the keyhole retainer clip on the tiller arm.



Be sure that the tiller extension hinge is on top.



Install the hiking stick.



INSTALLING THE RIGHTING LINE

A self-retracting righting-line is provided with the boat. Thread one end of the line through a grommet located at the rear of the trampoline (on one side or the other of the boat) from the bottom, going upwards. Tie a figure 8 knot in the end of the line. The knot will be on top of the trampoline and the righting-line below. Thread the other end of the righting-line forward to the main crossbar (under the boat). Pass the line through the ring attached to the underside of the main crossbar. Pass the line across the main crossbar to, and through, the other ring. Pass the line through then back to and up through the aft grommet on the opposite side. Pass the line upwards through the grommet. Tie a figure 8 knot in the end of the line (the knot will be on top of the trampoline).

Refer to page 15 for righting techniques.

NOTES:

The cooler lids may not be water tight. The storage areas are not to be considered dry storage areas.

Freezing weather conditions can damage the boat if water is trapped inside the hulls or aluminum extrusions. These areas must be drained and dry during freezing conditions



SAILING YOUR GETAWAY

Safe and sane guideline for the beginner; and an easy review for the experienced.

Always wear a life jacket when boating.

BALANCING THE BOAT

When sailing, sit on the upwind side of the boat (wind on your back) just in front of the tiller, facing the sail. Balance your weight further outboard as the boat begins to tip or heel over with the wind in the sails. Tuck one foot under the hiking strap for balance. Use your hand that is forward to hold and control the mainsheet. Use your hand that is aft to steer.

STEERING

Steer the boat by pushing the tiller away from you to turn towards the wind. Pull the tiller towards you to turn away from the wind. Keep the movement of the tiller to a minimum to prevent over-steering. This will help you keep the boat moving in a straight line as you pay attention to other watercraft and sail adjustments.

SAIL POWER

Face the sail in order to pay close attention to the trim or adjustment of the sail. When the front of the sail, just behind the mast, luffs or flutters in the breeze, you lose power. To start moving, pull the sail in just enough to stop the sail from luffing. There are also short ribbons hanging on either side of the sail. Follow the diagram of sail and course adjustments above using the "tell tails" to get the most performance out of the sail for all angles of sailing. The tell tails react to air flowing over the sail and will help you see that the sail is pulled in too tight or too loosely. If you pull the sail too tight you will stall the sail power. Ease the sail out until it luffs, then pull it in just a little until it stops luffing. You will adjust the trim whenever the wind changes direction or you change course.

Refer to the sail trim diagram below for approximate sail settings for the different points of sail or directions you will be sailing. Note the "can't sail zone". You cannot sail in this direction due to the fact that the sail will luff constantly when pointed into the wind. If you get stuck in irons (or stop pointed into the wind) you will need to reverse the rudder and push the sail forward to back-wind it. The jib should be back winded by the crew to assist. This will back the boat up. Reverse the rudders and let the sail out until the boat is positioned more across the wind (close reach). Then you can correctly trim the sail and start moving forward.

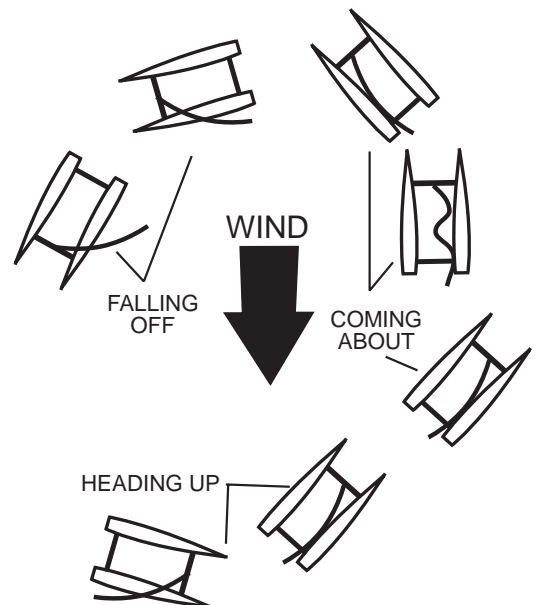
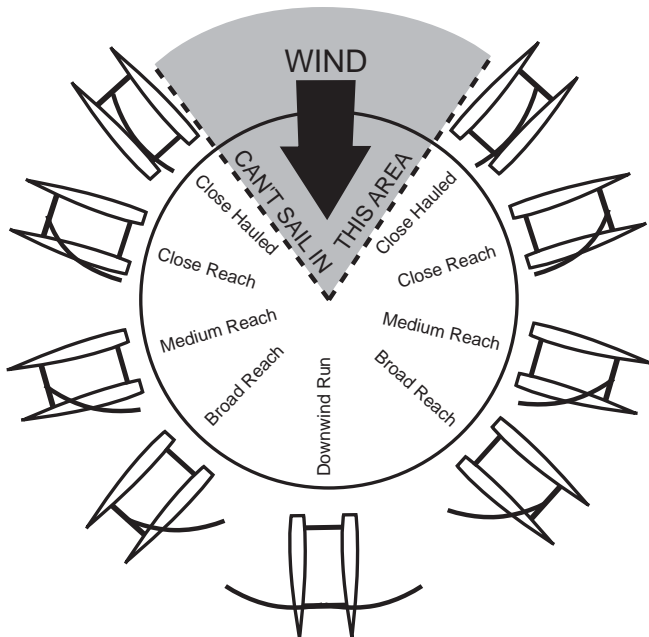
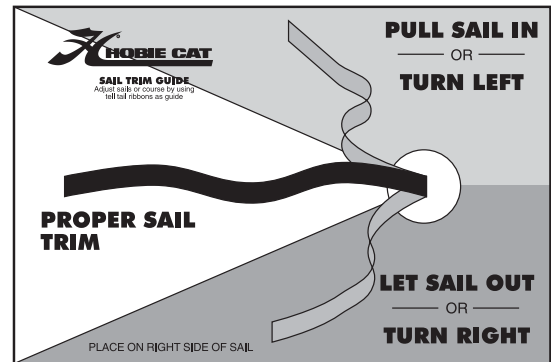
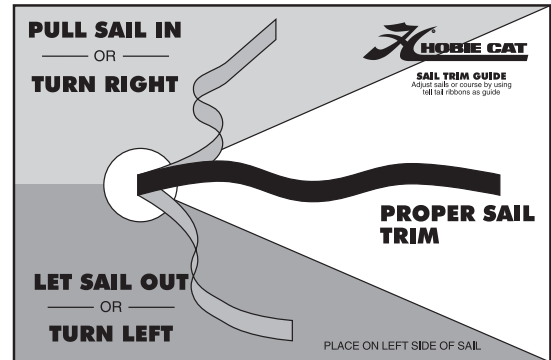

TURNING

To tack or turn the boat into and across the wind to the opposite direction (also known as "coming about"), follow the points of sail guide illustration and take the boat to the close hauled point of sail. This is when you are nearly 35 degrees from sailing straight into the wind. With the boat moving forward and not stalling, push the tiller away from you slowly. When the boat is pointing straight into the wind the boat will become level. Ease the mainsheet trim out just a little. At this time move your body to the other side of the boat, switch hands with tiller and mainsheet and begin to bring the rudder back to straight. The crew should move across the trampoline at the same time. The crew is responsible to ease the jib sheet just after the main sail is released and sheet the jib onto the new course before the mainsheet is trimmed. This action by the crew will prevent the boat stalling head to wind. As the boat comes across the wind and falls off onto the opposite, close hauled point of sail, bring the tiller all the way back to the straight position and pull the mainsail back in for the proper sail trim. If you stall pointing into the wind and you cannot steer the boat, refer back to the sail power description concerning getting stuck in irons.

When sailing downwind, the turn from one point of sail across to the other is called a jibe. The jibe is completed by turning away from the wind (falling off) to the opposite point of sail rather than into the wind as when tacking. Care must be taken when attempting a jibe as the boat will be at full power and you cannot easily de-power it without turning back into the wind. Also, be aware that the boat will be less stable in this maneuver as the sail will now have to swing clear across from fully out one side of the boat to fully out the other.

To start a jibe, turn the boat away from the wind and let the sail out slowly. Keep the turn going at a steady rate and begin pulling the sail back in as the boat nears the straight downwind direction. This will help prevent the sail from slamming all the way across when the sail fills from the opposite side. Duck below the sail to avoid getting hit as the wind fills the sail from the opposite side and swings across the boat. Attempt to control the speed of the sail while it crosses the deck by maintaining some tension on the mainsheet. Then ease the mainsheet out quickly as the boat turns past the downwind direction onto the new point of sail. Trim the sail correctly for the desired point of sail.

LAUNCHING THE BOAT

Launching the boat is easiest when the boat can be pointed into the wind to keep it de-powered and floated into deep enough water to lower the rudders. It is possible to launch in shallow water with the rudders partly up. Try not to steer with too much force on the rudders until you lock them in the down position. Keep the sail loose and trimmed out completely until you can power up and steer away from any obstacle. Trim the sail in quickly to get the boat moving forward and steer away from the wind slightly to prevent stalling into the wind.

When launching from a beach where the wind is blowing from the beach towards the water you simply keep the boat pointed

into the wind. Drift backwards with the rudders in the up position and your weight towards the front of the boat. Stay forward as the boat drifts into deeper water. You can hold the sail out to catch wind backwards to increase reverse speed. Then move to the rear and lower the rudders. It will be easiest to lower only one rudder while moving backwards. Then lower the other when the boat begins to move forward again. Be aware of the intended direction you wish to sail when lowering the rudder and steer the boat as the rudder drops into the water. There will be a lot of force on the rudder to turn one way or the other when going backwards. Plan ahead and steer the rudders so that they will be pointing in that direction before dropping it into the water. Steer the boat while going backwards so the bow turns away from the wind and toward the direction you wish to sail. As the sail begins to fill with wind, the boat will slow then begin to move forward. Trim in the sail and off you go.

RIGHTING THE BOAT

If you tip the boat over, stay with the boat. The boat will not sink and is easy to right. It is not necessary, but it is easier, to right the boat when the bow and the mast are pointed into the wind as in the following diagram.

There will be less wind resistance and better control in this position. Be sure the mainsheet is released, then swim around to the bottom of the boat. Skipper and crew should climb up on the hull and stand up. Using the righting line, skipper and crew pull the righting line that is against the upper hull and hold the line while slowly leaning back away from the trampoline. Lean to approximately 45 degrees for best leverage. As the mast and sail lift out of the water and the upper hull begins to drop back into the water, drop down to your knees then into the water. Hold onto the righting line near the crossbar or the crossbar itself near the hull that you were standing on. This will prevent the hull from being lifted into the air by momentum which could cause the boat to capsize once again. Be well aware of the hull and crossbar coming down over your head. Holding the crossbar or righting line will also insure that you remain with the boat when it is righted. Climb aboard and continue sailing.

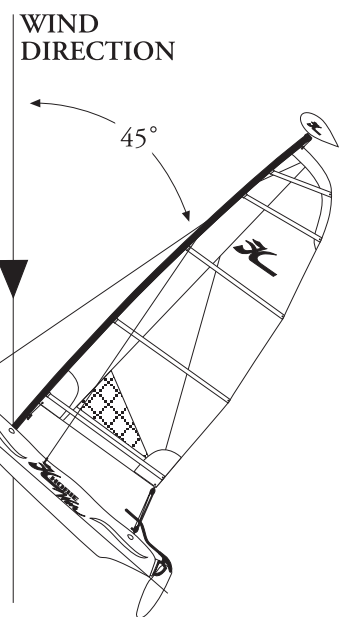

DOCKING

Docking the Getaway properly will prevent damage. Always dock and rig on the leeward side of a dock (the side the wind reaches last). Come in slowly and always be aware of the wind direction so you can properly de-power the boat when needed. The stronger the wind the more difficult the docking will be. Until you feel confident, you may want to practice with a friend who will remain on the dock and help slow you down if necessary.

BEACH LANDINGS

Landing on a beach is simple. The idea is to reach the beach in the point of sail nearest straight into the wind as possible. This will assure that you can properly de-power the sail once beached.

Approaching a beach when the wind is blowing from the beach out towards the water will require some planning so that you maintain power. Turn into shore just before the hulls or rudders touch bottom. Plan so the final tack towards the location you choose to land is the tack that is nearest straight into the wind. Get a little closer to the beach than you need on the previous tack to account for wind shifts in direction and speed. This will give you a little room for error. This will allow you to point a little further away from the wind after the tack to gain speed before heading up into the beach to de-power at the last moment.

When approaching a beach when the wind is blowing onshore, sail in towards the beach from either side of the landing spot. Sail in just short of touching the bottom with the rudders. Allow some distance to turn the boat out towards the water and into the wind just out from the landing spot. Turn sharply to head into the wind and stall the boat. Raise the rudders and drift back onto the beach.

Always keep the boat pointed into the wind while beached and keep the sail trimmed out and un-cleated.

RUDDER TUNING

You may adjust the rake of your rudder blades on your Hobie Getaway. The amount of rake in a rudder blade affects the "feel" at the tiller. Basically, more forward blade rake neutralizes the pull on the tiller and less forward rake increases the pull on the tiller. Tuning blades for a comfortable feel is a matter of individual preference but a close to neutral "feel" generally provides the best steering. The following sketches are of a Hobie 16 rudder assembly but the adjustments are the same.

1) The first step in making any rudder rake adjustment is to determine the existing rake. This is done with the rudder assembly hanging on the boat's transom, blade down and locked. Using a straight edge or snap line, extend the

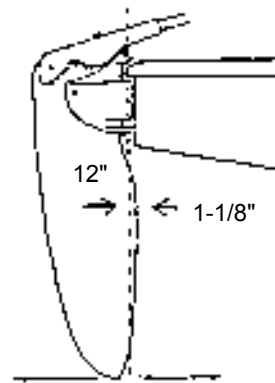

Aft for more pull on the tiller

Forward for less pull on the tiller

centerline of the rudder pivot pins down, across the leading edge of the blade and draw a pencil line along that length. Measure the distance from the pencil line to the most forward spot 12" down the blade from the bottom of the casting..

Rudder blade rake is pre-set at the factory to 1-1/8". This amount will be best for the average sailor and is a good starting point from which to begin any adjustments.

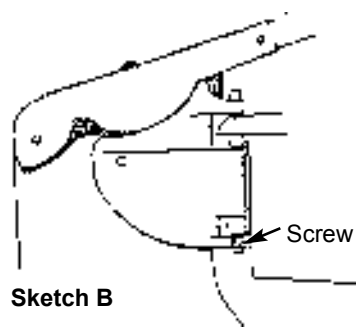

Sketch B

2) To make any adjustment to the rake, unlock the tiller arm from the rudder housing and leave it unlocked.

3) If you wish to increase the amount of forward rake in the rudder blade, turn the rake adjusting screw counterclockwise using a 3/16" Allen wrench. Determine the increase in the rake by extending a new line from the centerline of the pivot pins. Re-measure the distance from the pencil line to the leading edge. Continue to adjust and measure until you have the desired amount of forward rake.

4) If you wish to decrease the amount of forward rake turn the adjusting screw clockwise using a 3/16" Allen wrench. Check the decrease in the rake by the procedure in step 3 above .

5) Next, while holding the rudder forward against the lower casting, carefully latch the tiller arm down onto rudder housing. Loosen the adjusting screw on top of the tiller arm about 3/4 turn. Slide the adjusting screw forward (toward bow of boat) until it stops, then retighten. See sketch C.

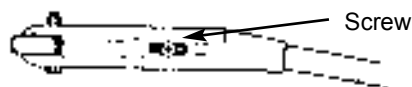

Sketch C



6) Hobie Cat rudder blades are preset to break away from the locked down position at 17-26 pounds by testing with a line around the rudder blade seven inches above the lowest tip of the blade. Once the rake is changed, the breakaway tension should be rechecked. The tension may be adjusted by turning the 3/4" internal screw in the housing. The screw tensions an internal spring. Turn it clockwise to increase and counter clockwise to decrease the tension.

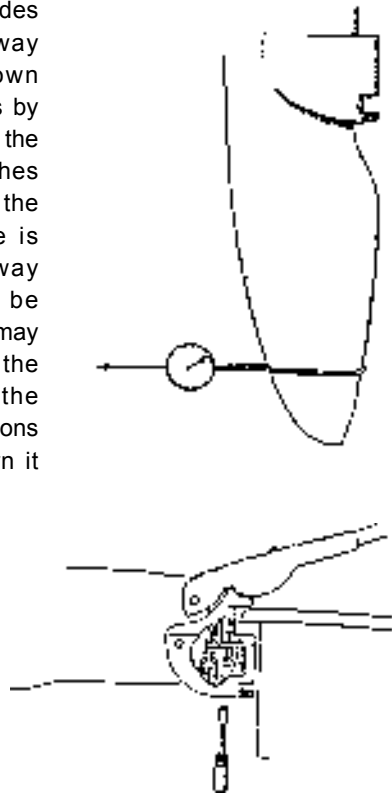

TRAILERING

CAUTION: Boat and mast should be securely attached to trailer with adequate tie-down straps. Failure to do so could cause extensive damage or serious injury!

LOADING YOUR TRAILER

The weight of the boat, equipment and additional gear should never exceed the manufacturer's rated weight capacity. Proper distribution of the load is of vital importance. Too much weight on the hitch will cause "tail dragging" of the towing vehicle, impairing steering and raising headlights into the eyes of oncoming traffic. Too little or negative weight on the hitch, and the trailer will sway or "fishtail". The solution to proper distribution is often adjusting movable gear. A more permanent solution is to shift the axle position before taking your boat to water the very first time.

TOWING

Extra caution is necessary when towing any trailer. The heavier the rig, the more time required to accelerate, pass, and stop. For this reason, the maximum speed for vehicles with trailers is less than without a trailer in most states. A long rig requires a larger turning radius. Curbs and obstructions should be given wide clearance. Most boats on trailers obstruct the rear view of the driver. When this happens, an additional rear view mirror on the right side of the towing vehicle is required by law.

The trailer boatman should be familiar with traffic and highway laws relating to the towing of trailers. Towing a Hobie has particular hazards that should be mentioned. A Hobie is very wide. Obstacles should be given plenty of room when you are passing them. Tie down straps or lashings should be of sufficient size and diameter and placed on all four corners.

The mast support on a trailer is subject to a lot of side-to-side motion and consequently may fatigue where it is welded to the trailer. All this can be reduced by tying a line from each bow to the mast support. This will stiffen the rig up and prolong the life of the trailer.

LAUNCHING AND RETRIEVING

Prepare boat for launching at the top of the ramp or parking facility. Remove all tie-down straps, check boat plugs and fasten boat painter. Do not release winch line until the boat is in the water. Back trailer to the left if possible; backing left gives better launching visibility. Avoid dunking wheel bearings wherever possible. Never leave the towing vehicle unattended on the ramp with only the parking brake set. If vehicle must be left while on the ramp, set transmission in "park" or first gear, in addition to setting the parking brake. In retrieving your boat, make sure that the boat is properly placed on the trailer. Pull trailer up steadily to prevent spinning the wheels.

MAINTENANCE

Lights: Most state laws require two red taillights on the rear that may be combined with the stop and turn signals. Vehicles over 80 inches in width require clearance lights. If lights are dunked, waterproof light fixtures should be used. If water is allowed to enter, the lamp may crack and short out the entire system. Water also promotes contact corrosion. Always carry spare lamps. The wire coupling to the towing vehicle should be high enough to stay dry. Never rely on the trailer hitch for ground connection. Four-pole connectors should be used.

The mast should not extend over three feet behind the rear light assembly.

Wheels: Tires should ALWAYS be inflated to manufacturer's recommended pressure. Always carry a spare wheel and a jack that fit the boat trailer. If wheel bearings are always dunked, waterproof bearings and caps should be considered. If water is allowed into the hub, lubricating grease will float away and bearings will burn out or seize, causing damage and a safety hazard. Waterproofed bearings should be inspected prior to each boating season, others more often. Special care should be given when traveling on unimproved roadways with small diameter wheels.

If a spare wheel is not available, a spare wheel bearing set should be taken on long trips in case the grease seal has been broken.

FRAME AND ROLLERS

Rust should not be allowed to accumulate. Remove rust and repaint with anti-rust paint. Some trailers offer galvanized coating to prevent rust. Rollers should roll freely and should not have checks, breaks or flat spots.

TOWING VEHICLE

Most vehicles are limited in towing capacity. Towing heavy loads places extra demands on the engine, transmission, brakes and other systems vital to the vehicle. Towing "packages" are available through most auto dealers and should be considered for heavy boats.

CAUTION / SAFETY TIPS

- **Watch for overhead power lines.** Never rig, trailer or sail the boat near overhead power lines. Contact with a power line could be fatal.
- **Sail to your experience.** Do not try to do more than you can. Do not take the Getaway out in the surf and do not head out for the ocean unless you are a real professional.
- **Wear a life jacket.** Wearing life vests while sailing is important for everyone. Due to the large number of novice sailors that have purchased the Getaway, it is even more important to review this safety issue. Wearing a life vest is a smart thing to do. Also, a sailboat could sail away by itself if a person were to fall overboard. The best advice to a sailor is to stay with the boat. If they happen to fall overboard, or when righting the boat, they should hold onto the boat and not let it get away.
- **Learn the right-of-way rules** and when in doubt, *give way* to others.
- **Adhere to car roof rack manufacturer's weight limitations and tie down suggestions when car-topping the Getaway.** (The combined weight of the Getaway hulls and mast is approx. 150 lbs.)
- **When trailering the Getaway be sure to tie the boat and all the loose parts to the trailer in a secure manner.** Stop and check the tie downs often.
- **Hobie Cat does not recommend leaving the Getaway in the water on a mooring.** Accelerated wear to the boat and rigging will be experienced. Damage to the hull material is possible. Limitation of the mast rotation and tensioning of the rigging are required to lessen this wear. Inspect rigging often and tape rigging rings and shackles to prevent loosening.



HOBIE CAT

4925 Oceanside Blvd.

Oceanside, CA. 92056

Phone (760) 758-9100 Fax (760) 758-1841



...The FUN starts here!

For your nearest HOBIE dealer
or
for help and information call:

1 (800) HOBIE - 49